

# POROUS MEDIA™ AIR BUSHING

## 20mm Inside Diameter



### 20mm ID Air Bushings

Second smallest of the New Way metric air bushing line, the 20mm ID size provides excellent load-carrying capability with the flexibility to fit into tight designs on metric shafting. These porous media bushings are an inexpensive way to achieve frictionless linear motion, and compare favorably with conventional rolling element bearings across virtually every performance characteristic. They are also easy to apply, replace or change.

SPECIFICATIONS: 20mm #S302001	
Input Pressure	.41 MPa (60psi)
Radial Load Max N (lbs)	133 (30)
Radial Stiffness N/μm (lbs/μ in)	23 (0.13)
Pitch Moment Max N-m (lbs-in)	1.1 (10.0)
Pitch Stiffness N-m/mil rad (lbs-in/mil rad)	2.8 (25)
Flowrate on Shaft NLPM (SCFH)	3.54 - 4.81 (7.50 - 10.20)
Air Gap (at maximum recommended load) microns	4
Bushing Inside Diameter - ID mm	+0.0051, -0.0000 20
Bushing Outside Diameter - OD mm (in)	31.8 (1.250)
Bushing Length mm (in)	51 (2.000)
Bushing Weight grams (oz.)	51.0 (1.80)
Housing Material/Finish	Aluminum/Anodized
Porous Media Material	Carbon
Recommended Shaft Outside Diameter - OD mm	20.0000
Recommended Shaft Tolerance (g6) μm	-7, -20
Pressure Port Threads	M3 x 0.5
Viable Pressure Range MPa (psi)	0.414 - 0.552 (60 - 80)
Maximum Allowable Pressure Supply MPa (psi)	0.689 (100)
Resolution	Infinite
Maximum Speed m/sec (f/sec)	50 (164.04)
Common Shaft Materials	Anodized aluminum, stainless steel, nickel plated steel, ceramics, glass

### TEST DATA – 20mm ID Air Bushing

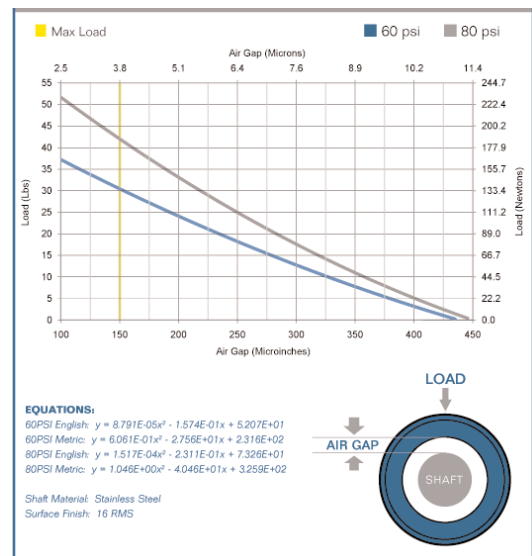

Lift/Load Data

# POROUS MEDIA™ AIR BUSHING

20mm ID

## ENGINEERING DRAWINGS AND MOUNTING DETAILS

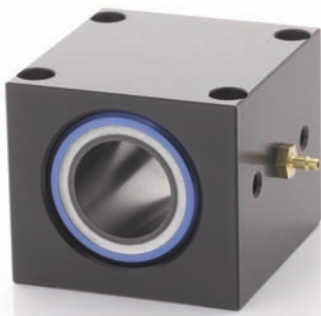
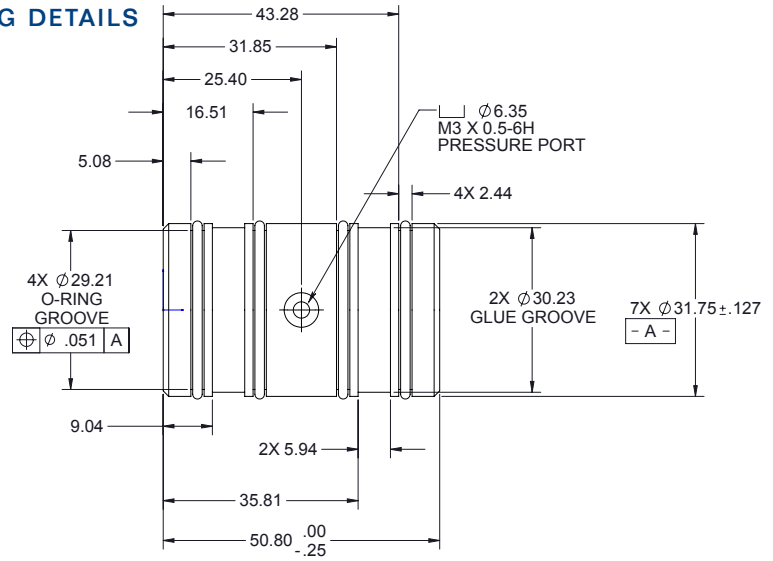
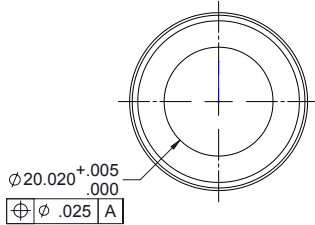

**AIR FITTINGS**  
All M3 Thread Size Air Fittings



**O-RINGS**  
S90RG2-024 - 20mm

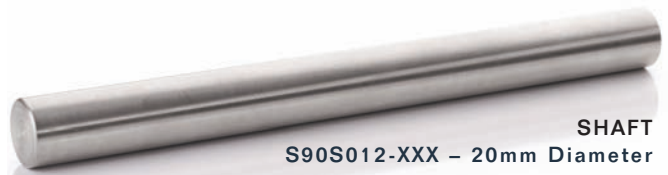

**SHAFT**  
S90S012-XXX - 20mm Diameter

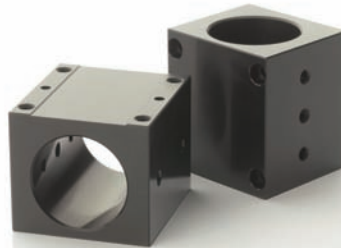

**MOUNTING BLOCKS**  
S8019P02 - 20mm I.D.

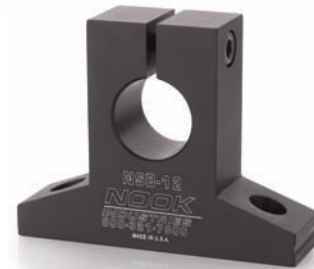

**END MOUNTS**  
S8020E02 - 20mm Diameter

## COMPLETE NEW WAY METRIC AIR BUSHING PRODUCT LINE



13mm ID



20mm ID



25mm ID



40mm ID



50mm ID



75mm ID



50 McDonald Blvd., Aston, PA 19014 USA • Phone: 610-494-6700 • Fax: 610-494-0911

www.newwayairbearings.com • info@newwayairbearings.com

